

# Owner's Manual

Arm-type Fully Automatic  
Digital Blood Pressure Monitor  
Model BP11



Arm Type



# Contents

<b>Safety Notice</b> .....	<b>1</b>
<b>Unit Illustration</b> .....	<b>3</b>
<b>Important Testing Guidelines</b> .....	<b>6</b>
<b>Quick Start</b> .....	<b>7</b>
<b>Unit Operation</b> .....	<b>8</b>
<b>Blood Pressure Information</b> .....	<b>16</b>
<b>Blood Pressure Q &amp; A</b> .....	<b>18</b>
<b>Maintenance</b> .....	<b>19</b>
<b>Specifications</b> .....	<b>21</b>
<b>Warranty</b> .....	<b>23</b>

## Safety Notice

Thank you for purchasing the BP11 Blood Pressure Monitor. The unit has been constructed using reliable circuitry and durable materials. Used properly, this unit will provide yeas of satisfactory use.

This device is intended for non-invasive measuring an adult individuals' systolic, diastolic blood pressure and heart rate using the oscillometric method. The device is not intended for use on infants and children. The device is designed for home or clinical use. All values can be read out in one LCD DISPLAY. Measurement position is on adult upper arm only.









Please read this manual thoroughly before using the unit. Please retain this manual forfuture reference. For specific information about your blood pressure, please

### CONSULT YOUR DOCTOR.

To avoid risk and damage follow all warning precautions. Operate unit only as intended. Read all instructions prior to use.

Blood pressure measurement determined with this device are equivalent to those obtained by a trained observer using the cuff/ stethoscope auscultation method, within the limits prescribed by the American National Standard (ANSI/AAMI SP10) for electronic Sphygmomanometers.

### WARNING SIGNS AND SYMBOLS USED

	Date of manufacturer
	Caution
	Type BF Equipment
	Consult Instructions For Use
<b>SN</b>	Serial Number
	Storage temperature and relative humidity
	The product conforms to the requirements of the EC Directive MDD(93/42/EEC) on medical devices
	Manufacturer
	Authorised Representative in the European Community

**Safety Notice**

1. Individuals with serious circulation problems may experience discomfort. Consult your physician prior to use.
2. Contact your physician if test results regularly indicate abnormal readings. Do not attempt to self-treat these symptoms without consulting your physician first.
3. Product is designed for its intended use only. Do not misuse in any way.
4. If you are taking medication, consult with your physician to determine the most appropriate time to measure your blood pressure. NEVER change a prescribed medication without first consulting with your physician.
5. People suffering from vascular constriction, liver disorders or diabetes, people with cardiac pacemakers or a weak pulse, and women who are pregnant should consult their physician before measuring their blood pressure themselves. Different values may be obtained due to their condition.
6. For persons with irregular or unstable circulation resulting from diabetes, liver disease, arteriosclerosis or other medical conditions, there may be variations in blood pressure values measured at the wrist versus at the upper arm. Monitoring the trends in your blood pressure taken at either the arm or the wrist is nevertheless useful and important.
7. People suffering from arrhythmias such as atrial or ventricular premature beats or atrial fibrillation only use this blood pressure monitor in consultation with your doctor. In certain cases oscillometric measurement method can produce incorrect readings.
8. Product is not intended for infants or individuals who cannot express their intentions.
9. Do not disassemble or attempt to repair.
10. Do not use cell phones and other devices, which generate strong electrical or electromagnetic fields, near the device, as they may cause incorrect readings and interference or become interference source to the device.
11. Any hazards associated with prolonged overinflation of the bladder.
12. Only use a recommended AC adaptor complying with EN 60601-1 and EN 60601-1-2 (see page 6). An unauthorized adaptor may cause fire and electric shock.

**Battery Precautions**

Do not mix new and old batteries simultaneously.

Replace batteries when Low Battery Indicator “” appears on screen.

Be sure battery polarity is correct.

Do not mix battery types. Long-life alkaline batteries are recommended.

Remove batteries from device when not in operation for more than 3 months.

Dispose batteries properly; observe local laws and regulations.

## Unit Illustration

### Monitor Unit

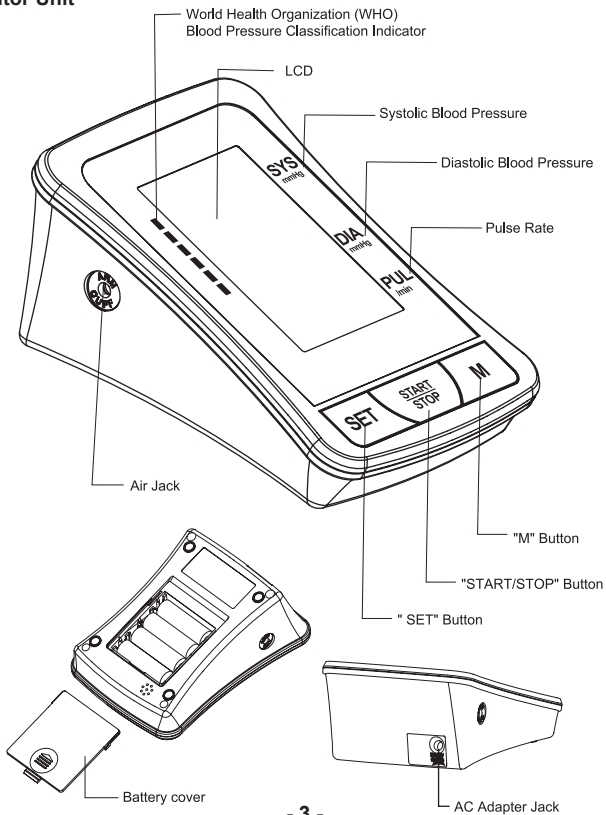

## Arm Cuff

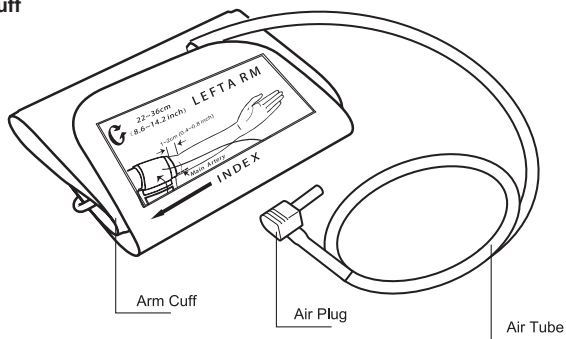

## Display

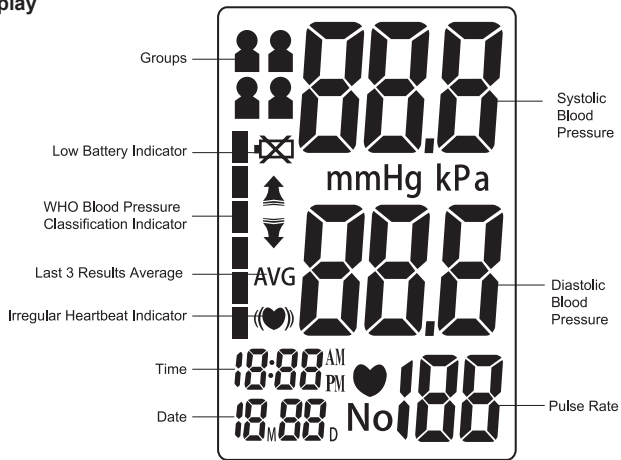

Contents

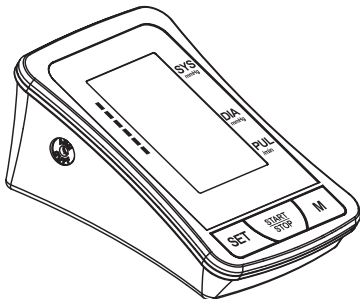

1. Monitor Unit

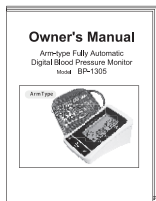

2. Owner's Manual

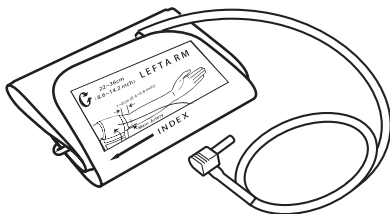

3. Arm Cuff

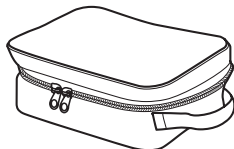

4. Storage Case



5. Medical AC Adapter(DC6.0 V,600mA)  
(recommended, not provided)



## Important Testing Guidelines

1. Avoid eating, exercising, and bathing for 30 minutes prior to testing.
2. Sit in a calm environment for at least 5 minutes prior to testing.
3. Do not stand while testing. Sit in a relaxed position while keeping your arm level with your heart.
4. Avoid speaking or moving body parts while testing.
5. While testing, avoid strong electromagnetic interference such as microwave ovens and cell phones.
6. Wait 3 minutes or longer before re-testing.
7. Try to measure your blood pressure at the same time each day for consistency.
8. Test comparisons should only be made when monitor is used on the same arm, in the same position, and at the same time of day.
9. This blood pressure monitor is not recommended for people with severe arrhythmia.

Any blood pressure recording can be affected by the following factors:

1. The position of the subject, his or her physiologic condition;
2. The performance and accuracy of the device;
3. Cuff size: too small cuff (bladder) will produce a higher blood pressure value than usual, too big cuff (bladder) will produce a lower blood pressure value;
4. Measuring position does not keep level with your heart;
5. Speaking or moving body parts while testing;
6. Not relaxing for about 5 minutes before taking the measurement.

**Quick Start**

1. Install batteries. (See Figure A)
2. Insert cuff air plug into the left side of monitor unit. (See Figure B)

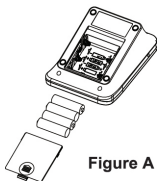

Figure A

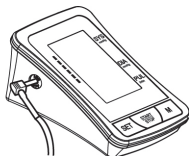

Figure B

3. Remove thick clothing from the arm area.
4. Rest for several minutes prior to testing. Sit down in a quiet place, preferably at a desk or table, with your arm resting on a firm surface and your feet flat on the floor. (See Figure C)



Figure C

5. Apply cuff to your left arm and keep level with your heart. Bottom of cuff should be placed approximately 1-2cm (0.4-0.8") above elbow joint. (See Figures D&E)

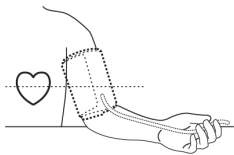

Figure D

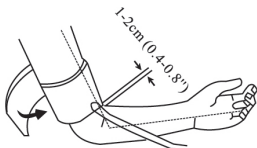

Figure E

6. Press "START/STOP" Button to start testing.

## Unit Operation

### Battery Installation

Slide battery cover off as indicated by arrow.

Install 4 new AA alkaline batteries according to polarity.

Close battery cover.

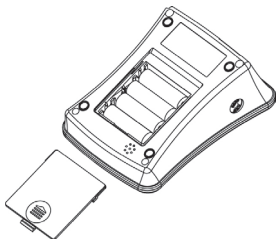

AC Adapter jack is on the right side of the monitor. Medical AC adapter(DC 6.0 V, 600mA) can be used with the device (recommended, not provided). The adapter connect pin should be positive inside and negative outside with a 2.1mm coaxial joint. Do not use any other type of AC adaptor as it may harm the unit.

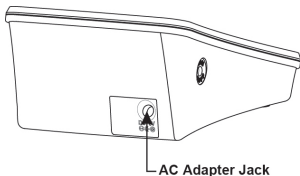

### System Settings

#### 1. Select Memory Group

While in the System Setting mode, you may accumulate test results into 2 different groups. This allows multiple users to save individual test results (up to 60 memories per group.) Press " M " button to choose a group setting. Test results will automatically store in each selected group.

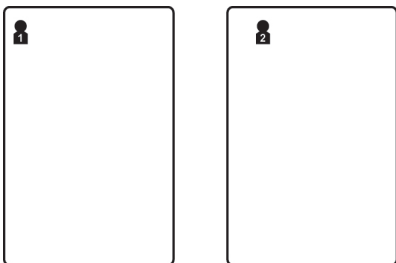

## 2. Time /Date Setting

Press “SET” button again to set the Time/Date mode. Set the month first by adjusting the “ M “ button. Press “SET “ button again to confirm current month. Continue setting the day, hour, and minute in the same fashion. Every time the “ SET “ button is pressed, it will lock in your selection and continue in succession (month, day, hour, minute.)



## 3. Saved Settings

While in any setting mode, press “ START/STOP “ button to turn the unit off. All information will be saved.

Note: If unit is left on and not in use for 3 minutes, it will automatically save all information and shut off.

## Applying the Arm Cuff

1. Firmly insert air plug into opening located on left side of monitor unit.

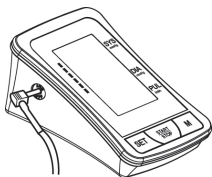

2. With sticky nylon section facing outward, insert end of cuff underneath metal ring of cuff
3. Fasten cuff about 1-2cm (0.4-0.8") above the elbow joint..For best results apply cuff to bare arm and keep level with heart while testing.

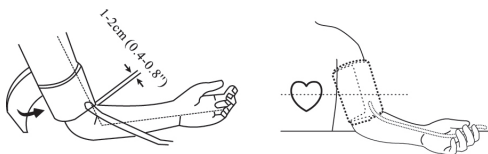

Note: Do not insert air plug into opening located on right side of monitor unit. This opening is designed for an optional power supply only.

## Testing

### 1. Power On

Press and hold " START/STOP " button until a beep sounds. The LCD screen will appear for one second as unit performs a quick diagnosis. A long tone indicates device is ready for testing.

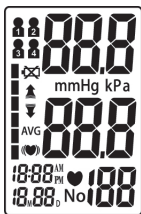

Note: Unit will not function if residual air from previous testing is present in cuff.

The LCD will flash “” until pressure is stabilized.

## 2. Pressurization

Initial pressure is first pumped to 190 mmHg. If the current user's systolic blood pressure is over 190mmHg, the unit will automatically re-inflate to the proper shelf.

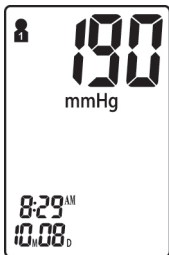

Note: Pressurization will gradually subside and ultimately stop when cuff is not properly applied to the arm. If this occurs, press “ START/STOP ”button to turn the unit off.

## 3. Testing

After cuff inflation, air will slowly subside as indicated by the corresponding cuff pressure value. A flashing “” will appear simultaneously on screen signaling heart beat detection.

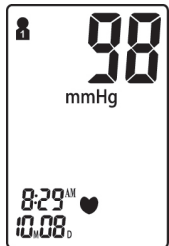

Note: Keep relaxed during testing. Avoid speaking or moving body parts.

## 4. Result Display

Three short beeps sound when testing is complete. The screen will display measurements for systolic and diastolic blood pressure. A indicator representing the current measurement will appear next to the corresponding WHO Classification.

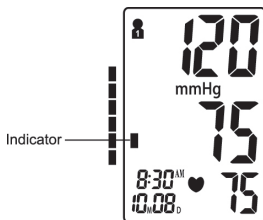

Note: Refer to Page 23~24 for detail WHO Blood Pressure Classification Information.

### Irregular Heartbeat Indicator

If the monitor detects an irregular heart rhythm two or more times during the measuring process, the Irregular Heartbeat Symbol “(♥)” appears on screen along with measurement results. Irregular heartbeat rhythm is defined as rhythm that is either 25% slower or faster than the average rhythm detected while measuring systolic blood pressure and diastolic blood pressure. Consult your physician if the Irregular Heartbeat Symbol “(♥)” frequently appears with your test results.

### 5. Deleting/Storing Test Results

User may delete their current test result due to unfavorable testing conditions or for any other reason. To delete the last test result, press the “SET” button after result is displayed. If result is not deleted, it will automatically store by date within the previously configured Memory Group.

Note: Be sure the appropriate Memory Group selection is made prior to testing.

If the number of tests surpasses the allotted 60 memories per group, the most recent tests will appear first, thus eliminating the oldest readings.

### Power Off

The “START/ STOP” button can be pressed to turn off the unit in any mode. The unit can turn off the power itself about 3 minutes no operation in any mode.

**⚠ Safety Precaution:** If pressure in arm cuff becomes too extreme while testing, press the “START/STOP” button to turn power off. The cuff pressure will rapidly

dissipate once the unit is off.

### Memory Check

With power off, you may check past test results by using the “ M ” buttons. The most recent test result and oldest test result in memory can be viewed by pressing and holding the “ M ” button upon activating test results you can press the “ M ” button to scroll through all test results stored in memory.

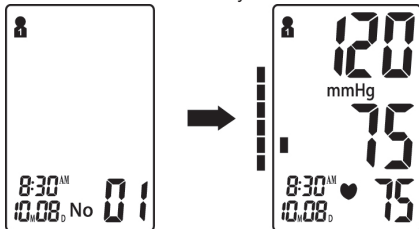

Note: Previous test results will only be displayed from the most recently used memory group. To check previous test results in other memory groups, you must first select the desired group and then turn monitor off. (See “ Select Memory Group ” on Page 10.)

### Memory Deletion

Memory for a selected group may be deleted while in Memory Check mode. Press and hold the “ SET ” button for approximately 3 seconds to delete all memory records from the selected group. The monitor will beep indicating successful deletion and then transfer into testing mode. Press the “ START/STOP ” button to turn the unit off.

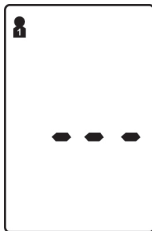

Note: Memory cannot be recovered once it has been deleted.

### Last 3 Tests Average

With power off, press and hold the “ M ” button to activate screen display. After the



unit performs a self diagnosis, the screen will display the average test results from the last 3 readings of the last group used. The “AVG” symbol will appear along with the corresponding WHO Blood Pressure Indicator. The Memory Check mode can be accessed by pressing the “M” buttons. To check the average results from other groups, select the desired group first prior to activating the “M” button in the off position. (See “Select Memory Group” on Page 10.)

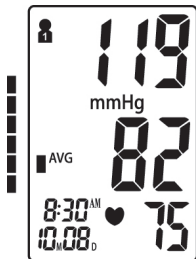

Note: In this mode, user can access to test mode by pressing “M” button.

### Low Battery Indicator

4 short warning beeps sound when battery life is depleting and unable to inflate cuff for testing. The “” appears simultaneously for approximately 5 seconds prior to shutting off. Replace batteries at this time. No memory loss will occur throughout this process.

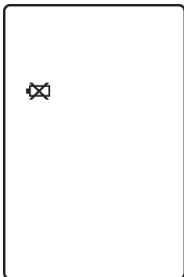

### Troubleshooting

Problem	Possible Cause	Solution
Blood pressure results are not within typical range	Cuff is too tight or not properly positioned on the arm	Firmly reposition cuff approximately 1-2cm (1/2") above the elbow joint( See Page 12)
	Inaccurate test results due to body movement or monitor movement	Sit in a relaxed position with arm placed near heart.. Avoid speaking or moving body parts while testing. Make sure the monitor unit is placed in a stationary position throughout the testing period. ( See Page 7)
"Err" displayed	Cuff fails to inflate properly	Make sure hose is properly fastened to cuff and monitor unit
	Improper operation	Read user manual carefully and re-test properly.
	Pressurization is over 300mmHg	Read user manual carefully and re-test properly.

## Blood Pressure Information

### Blood Pressure

Blood pressure is the force of blood pushing against the walls of arteries. It is typically measured in millimeters of mercury (mmHg.) Systolic blood pressure is the maximum force exerted against blood vessel walls each time the heart beats. Diastolic blood pressure is the force exerted on blood vessels when the heart is resting between beats.

An individual's blood pressure frequently changes throughout the course of a day. Excitement and tension can cause blood pressure to rise, while drinking alcohol and bathing can lower blood pressure. Certain hormones like adrenaline (which your body releases under stress) can cause blood vessels to constrict, leading to a rise in blood pressure.

If these measuring numbers become too high, it means the heart is working harder than it should.

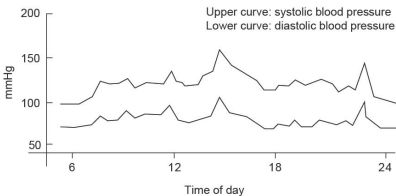

Example: fluctuation within a day (male, 35 years old)

### WHO Blood Pressure Classification Indicator

The BP11 is equipped with a classification indicator based on established guidelines from the World Health Organization. The chart below (color coded on monitor unit) indicates test results.

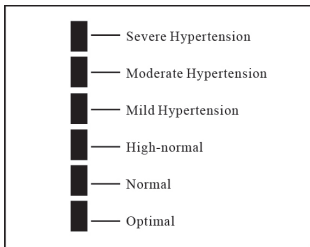

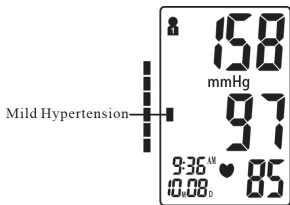

■: Classification Indicator Blood Pressure

### Health Reminder

Hypertension is a dangerous disease that can affect the quality of life. It can lead to a lot of problems including heart failure, kidney failure, and cerebral hemorrhaging. By maintaining a healthy lifestyle and visiting your physician on a regular basis, hypertension and relative diseases are much easier to control when diagnosed in their early stages.

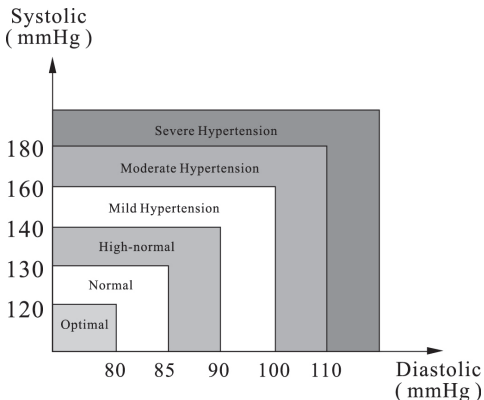

Note: Do not be alarmed if an abnormal reading occurs. A better indication of an individual's blood pressure occurs after 2-3 readings are taken at the same time each day over an extended period of time. Consult your physician if test results remain abnormal.

## Blood Pressure Q & A

Q: What is the difference between measuring blood pressure at home or at a professional healthcare clinic?

A: Blood pressure readings taken at home are now seen to give a more accurate account as they better reflect your daily life. Readings can be elevated when taken in a clinical or medical environment. This is known as White Coat Hypertension and may be caused by feeling anxious or nervous.

Note: Abnormal test results may be caused by:

1. Improper cuff placement

Make sure cuff is snug-not too tight or too loose.

Make sure bottom of the cuff is approximately 1-2cm (1/2") above the elbow joint.

2. Improper body position

Make sure to keep your body in an upright position.

3. Feeling anxious or nervous

Take 2-3 deep breaths, wait a few minutes and resume testing.

Q: What causes different readings?

A: Blood pressure varies throughout the course of a day. Many factors including diet, stress, cuff placement, etc. may affect an individual's blood pressure.

Q: Should I apply the cuff to the left or right arm? What is the difference?

A: Either arm can be used when testing, however, when comparing results, the same arm should be used. Testing on your left arm may provide more accurate results as it is located closer to your heart.

Q: What is the best time of day for testing?

A: Morning time or any time you feel relaxed and stress free.

## Maintenance

1. Avoid dropping, slamming, or throwing the unit.

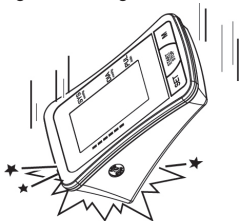

2. Avoid extreme temperatures. Do not expose unit directly under sunshine.

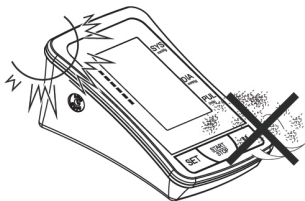

3. When cleaning the unit, use a soft fabric and lightly wipe with mild detergent. Use a damp cloth to remove dirt and excess detergent.



- Cuff Cleaning: Do not soak cuff in water! Apply a small amount of rubbing alcohol to a soft cloth to clean cuff's surface. Use a damp cloth (water-based) to wipe clean. Allow cuff to dry naturally at room temperature.
- Do not use petrol, thinners or similar solvents.

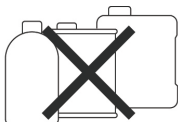

- Remove batteries when not in operation for an extended period of time.

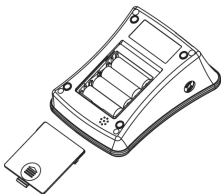

- Do not disassemble product.

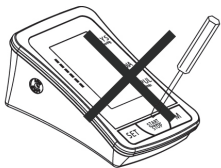

- It is recommended the performance should be checked every 2 years.
- Expected service life: Approximately three years at 30 tests per day.

## Specifications

Product Description	Arm-type Fully Automatic Digital Blood Pressure Monitor	
Model	Bp11	
Display	LCD Digital Display Size: 62.7mm×46.4mm (3.31" x 2.17")	
Measurement Method	Oscillometric Method	
Measurement Range	Pressure	0mmHg~300mmHg
	Pulse	30 to 180 Beats/Minute
Measurement Accuracy	Pressure	±3mmHg
	Pulse	±5%
Pressurization	Automatic Pressurization	
Memory	120 Memories	
Function	Low Battery Detection	
	Automatic Power-Off	
Power Source	4 AA batteries or Medical AC Adapter(DC6.0V, 600mA) (recommended, not provided)	
Battery Life	Approximately 2 months at 3 tests per day	
Unit Weight	Approx.405g (14.30 oz.) (excluding battery)	
Unit Dimensions	Approx.134 x 99 x 66mm (4.33" x 6.10" x 2.76" )(L x W x H)	
Cuff Circumference	Approx.135 (W)×485(L) mm (Medium cuff: Fits arm circumference 22-36 cm)	
Operating Environment	Temperature	10°C ~ 40°C (50°F ~104°F)
	Humidity	15%~90% RH
	Pressure	Atmospheric Pressure



Storage Environment	Temperature:	-20 C ~55 C (-4 F ~131 F )
	Humidity	15%~90% RH
	Pressure	525mmHg~795mmHg
Classification:	Internal Powered Equipment, Type BF  .Cuff is the Applied Part	

Specifications are subject to change without notice.

This Blood Pressure Monitor complies with the European regulations and bears the CE mark "CE 0123".This blood pressure monitor also complies with mainly following standards (included but not limited):

Safety standard:

EN 60601-1 Medical electrical equipment part 1: General requirements for safety

EMC standard:

EN 60601-1-2 Medical electrical equipment part 1-2: General requirements for safety- Collateral standard: Electromagnetic compatibility- Requirements and tests

Performance standards:

EN 1060-1 Non-invasive sphygmomanometers - General requirements

EN 1060-3 Non-invasive sphygmomanometers - Supplementary requirements for electromechanical blood pressure measuring systems.

EN 1060-4 Non-invasive sphygmomanometers - Test procedures to determine the overall system accuracy of automated non-invasive sphygmomanometers.

### Correct Disposal of This Product

Discard the used product to the recycling collection point according to local regulations.

## Warranty

The Blood Pressure Monitor is guaranteed for 2-year from the date of purchase. If the Blood Pressure Monitor does not function properly due to defective components or poor workmanship, we will repair or replace it freely. The warranty does not cover damages to your Blood Pressure Monitor due to improper handling. Please contact local retailer for details.



Document No.DBP-1404-002Z  
Version:V.Z  
Date of Issue: 2011.11



The product is in compliance with the requirements of MDD93/42/EEC."0123" is the identification number of notify body.



Shanghai International Holding Corp.GmbH(Europe)  
Eiffestraße 80,20537 Hamburg GERMANY